

MAGELLAN DESIGNS

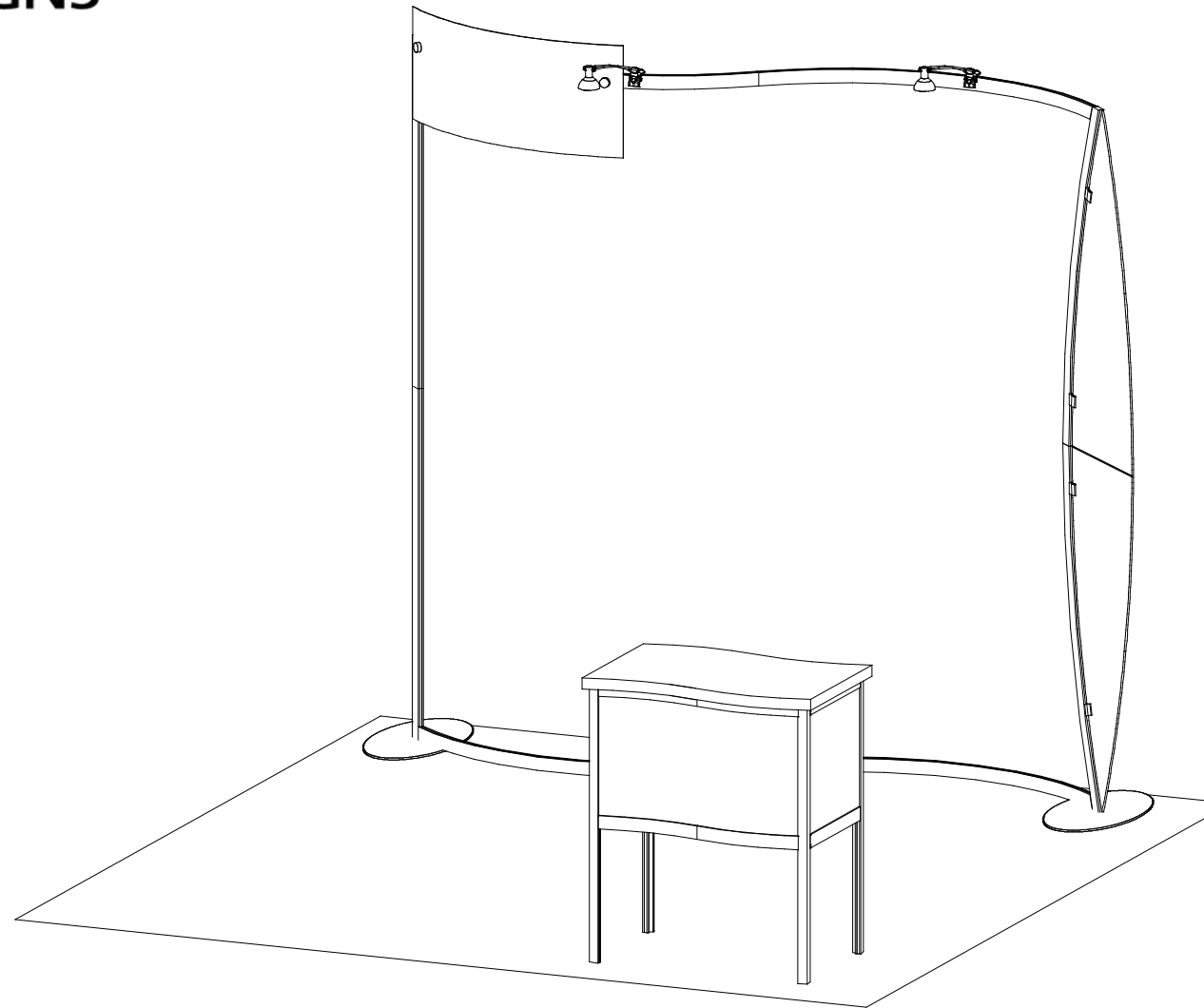
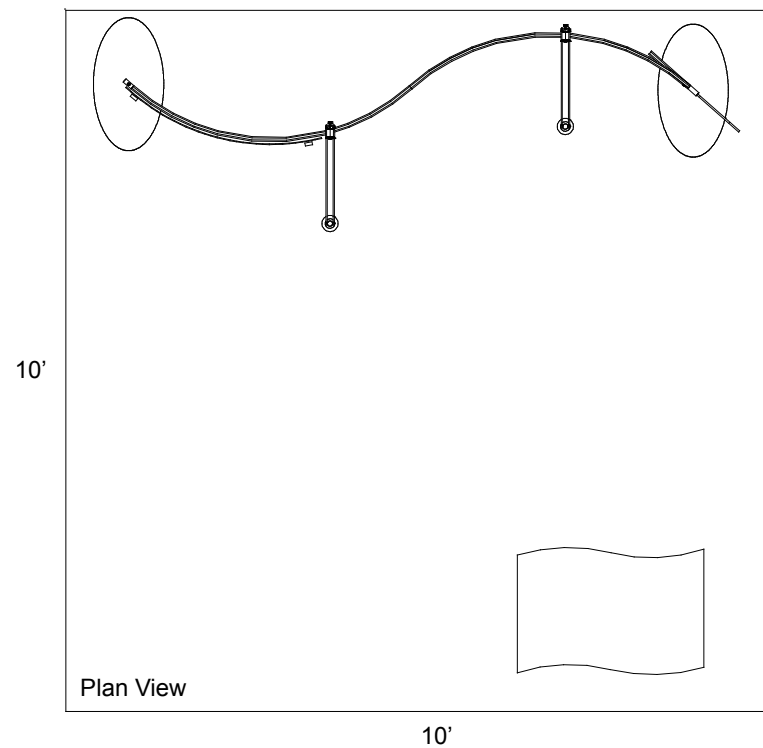

WHEN DISASSEMBLING ALUMINUM EXTRUSION, TIGHTEN ALL SETSCREWS AND LOCKS TO PREVENT LOSS DURING SHIPPING

MAGELLAN DESIGNS

Using Your Set-up Instructions:

The Visionary Designs Set-up Instructions for Magellan displays are created specifically for your configuration. They are laid out sequentially, including an exploded view of the entire display and a logical series of detailed steps for assembly. We encourage you to study the instructions **before** attempting to assemble your exhibit.

THIS IS VERY IMPORTANT!

Each page reminds you to tighten the setscrews after disassembling your exhibit to prevent loss of the locks and setscrews (see below in red).

Cleaning & Packing Your Display:

- 1) Use care when cleaning aluminum extrusions or acrylic inserts. Use only non-abrasive cleaners.
- 2) When cleaning laminate inserts or counter tops, use mild cleansers and a soft material such as cotton.
- 3) Keep all display components away from extreme heat and long exposure to sunlight to avoid warping and fading.
- 4) Retain all packing materials. It will make re-packing much easier and will reduce the likelihood of shipping damage.

Hex Key Tool



Most visionary design exhibits can be assembled with the supplied Hex Key Tool. Occasionally, a flat head screwdriver may be required.

Typical Connection



Detail A: Most horizontal extrusion connections have a patented expandable lock. This lock inserts into the groove of an opposing extrusion. Tightening the lock with the Hex Key Tool expands the lock and creates a strong positive connection.

Typical Connection

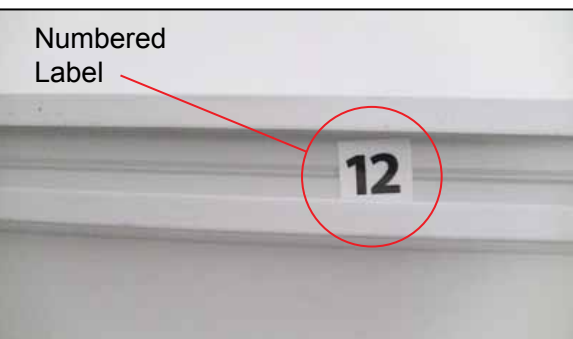

Detail B: Each extrusion contains a numbered label that corresponds to set-up instructions. The label is located within a groove of the extrusion (when possible). Visionary Design labels contain Black numbers unless otherwise specified.

Horizontal Connection

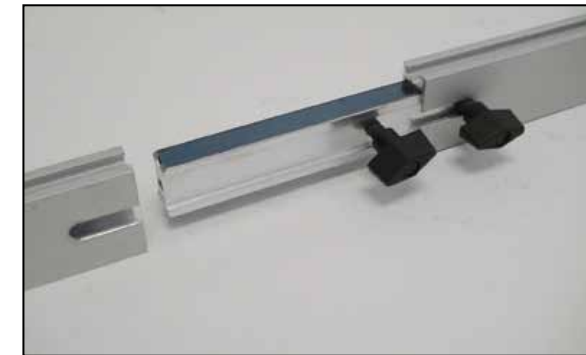

Detail C: A rectangular connection bar with plastic T Knobs is inserted between two horizontal extrusions joined end-to-end. Turn the knobs clockwise to tighten. Do Not Overtighten.

WHEN DISASSEMBLING ALUMINUM EXTRUSION, TIGHTEN ALL SETSCREWS AND LOCKS TO PREVENT LOSS DURING SHIPPING

Part Number	Qty	Description
1	2	Base Plate
2	1	47" h Lower Vertical Extrusion
3	1	47" h Upper Vertical Extrusion
4	1	48.115" Lower Curved Extrusion
5	1	48.115" Upper Curved Extrusion
6a/6b	1/1	52.476" Horizontal Curved Extrusion
7a/7b	1/1	52.476" Horizontal Curved Extrusion

Steps:

- 1) Attach vertical extrusions to base plates [2 to 1 and 4 to 1].
- 2) Connect vertical pieces together [2 to 3 and 4 to 5].
- 3) Connect curved extrusions together [6a to 6b and 7a to 7b].
- 4) Attach horizontal assemblies [6a/6b and 7a/7b] between vertical assemblies [2/3 and 4/5] as shown.

RED STAR indicates location of connection bar with knobs on BACKSIDE of unit.

Rear View of Display

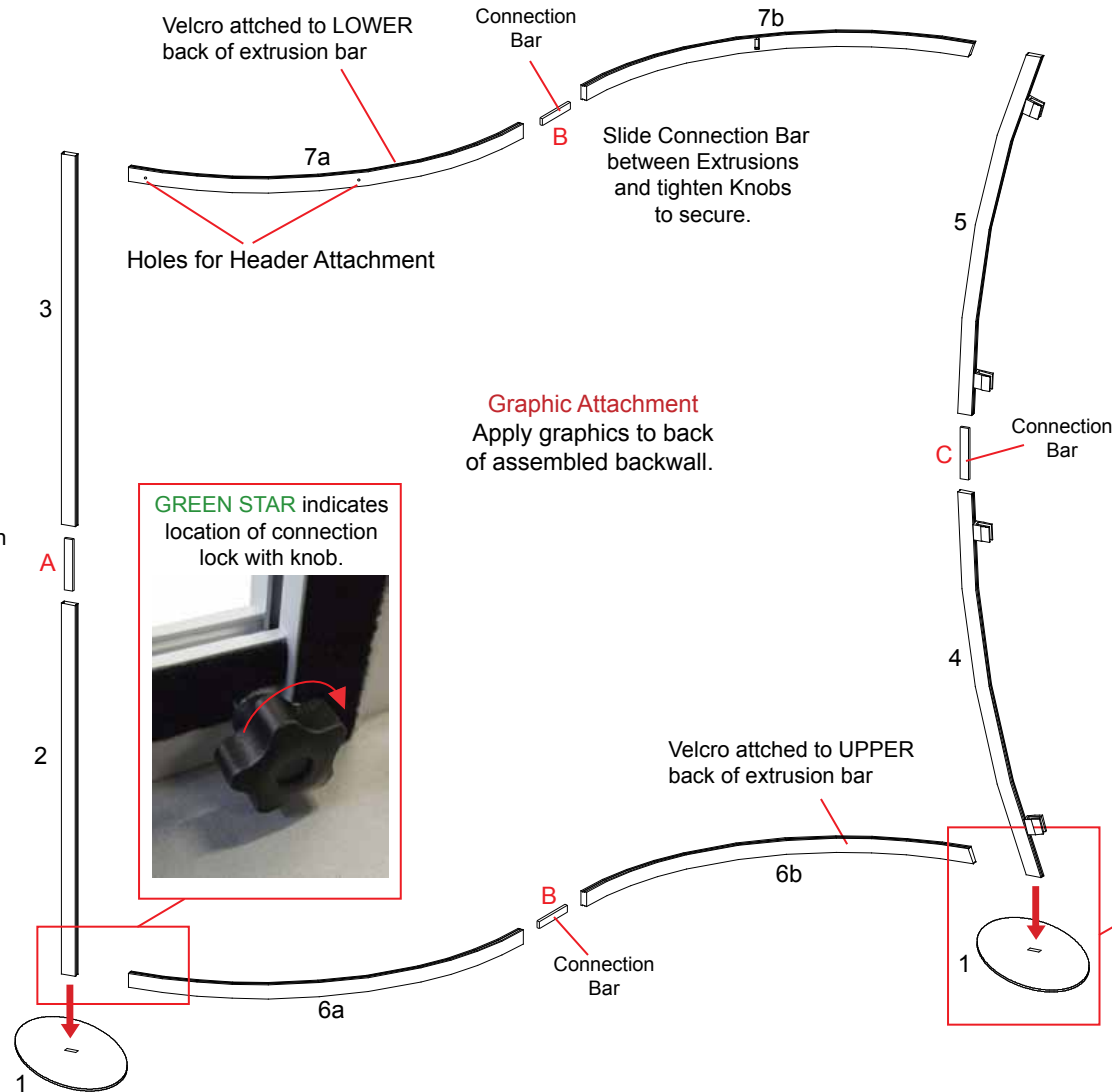
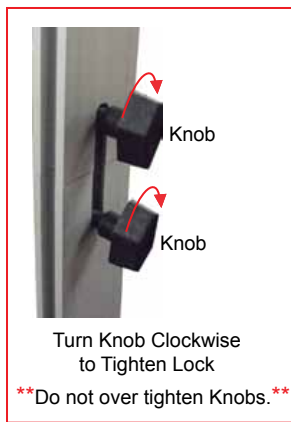
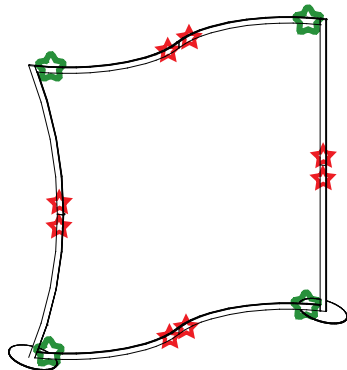

Graphic Attachment
Apply graphics to back of assembled backwall.

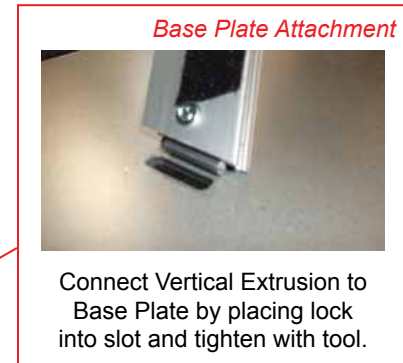

WHEN DISASSEMBLING ALUMINUM EXTRUSION, TIGHTEN ALL SETSCREWS AND LOCKS TO PREVENT LOSS DURING SHIPPING

866.652.2100

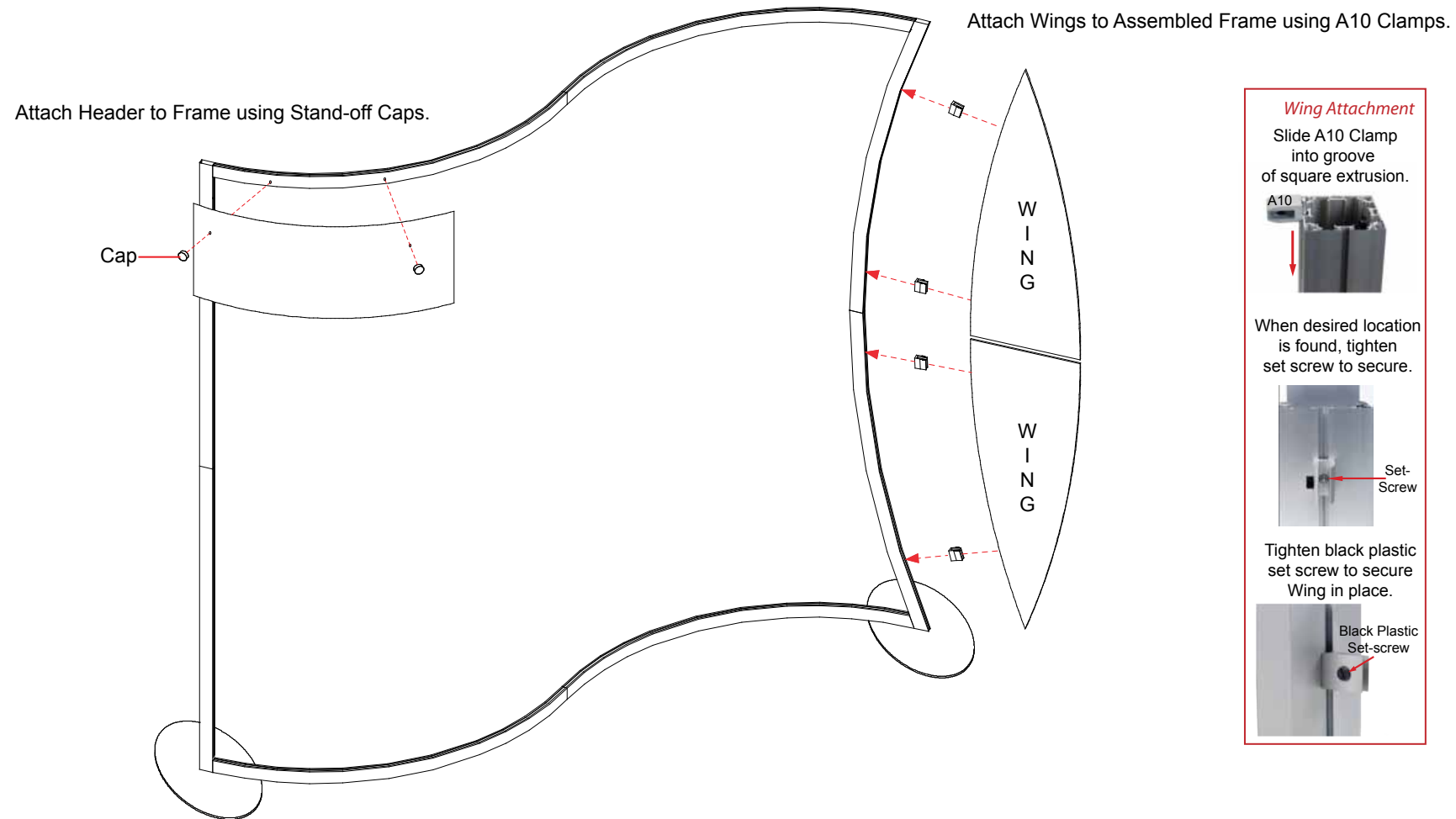

Wing Attachment

Slide A10 Clamp into groove of square extrusion.



A10

When desired location is found, tighten set screw to secure.



Set-Screw

Tighten black plastic set screw to secure Wing in place.



Black Plastic Set-screw

WHEN DISASSEMBLING ALUMINUM EXTRUSION, TIGHTEN ALL SETSCREWS AND LOCKS TO PREVENT LOSS DURING SHIPPING

866.652.2100

Item	Qty.	Description
8	1	37.50"h Vertical Extrusion
9	1	37.50"h Vertical Extrusion
9A	1	Door Stop
10	1	37.50"h Vertical Extrusion
11	1	37.50"h Vertical Extrusion
12	2	Horizontal Extrusion w/ Lip
13	2	Horizontal Extrusion
14	4	Curved Horizontal Extrusion

Steps

- 1) Connect lower horizontal extrusions [12 and 14] between vertical extrusions [8, 9, 10 and 11] as shown.
- 2) Place inserts and attach door where indicated.
- 3) Attach upper horizontal extrusions [13 and 14] between vertical extrusions [8, 9, 10 and 11] and atop inserts and door.
- 4) Place shelf atop lip of extrusions [12].
- 5) Set counter top on assembled pedestal.

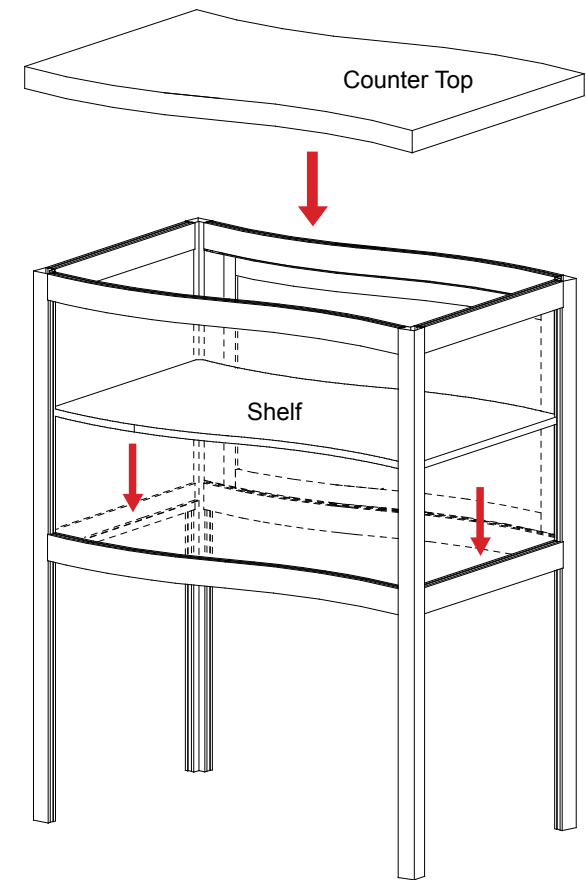
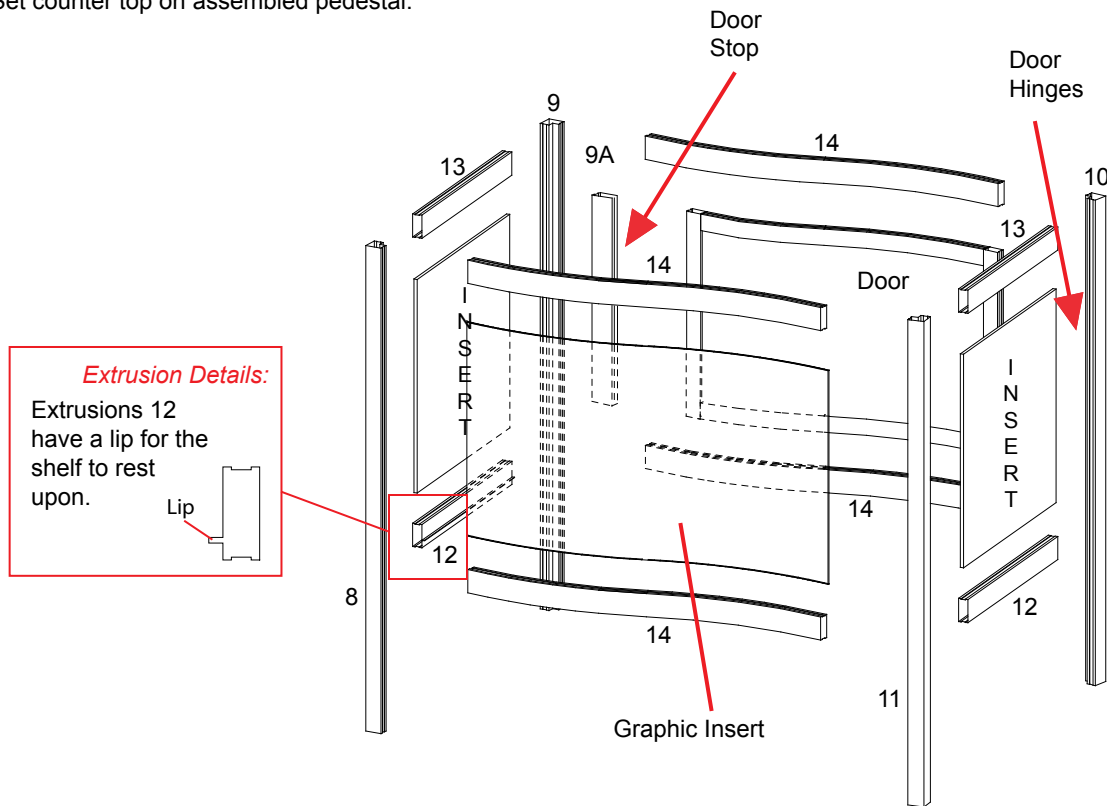

WHEN DISASSEMBLING ALUMINUM EXTRUSION, TIGHTEN ALL SETSCREWS AND LOCKS TO PREVENT LOSS DURING SHIPPING

Backwall Components

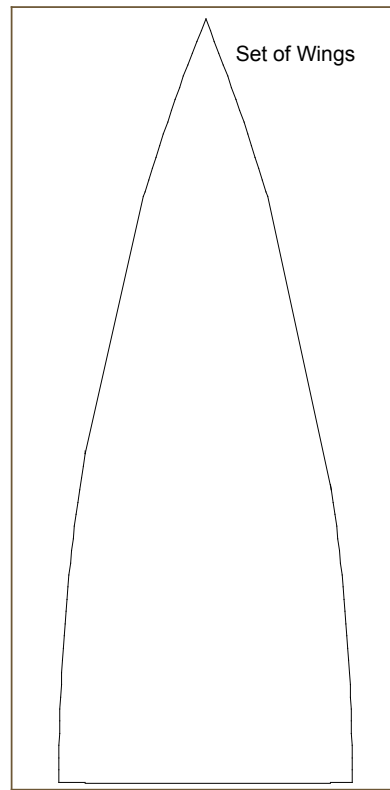

Level 1

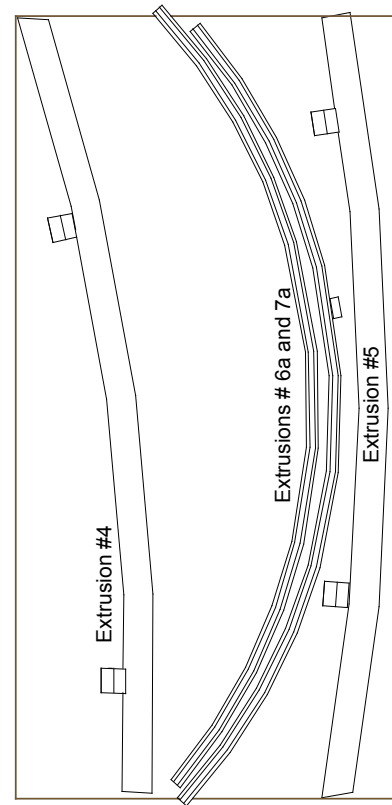

Level 2

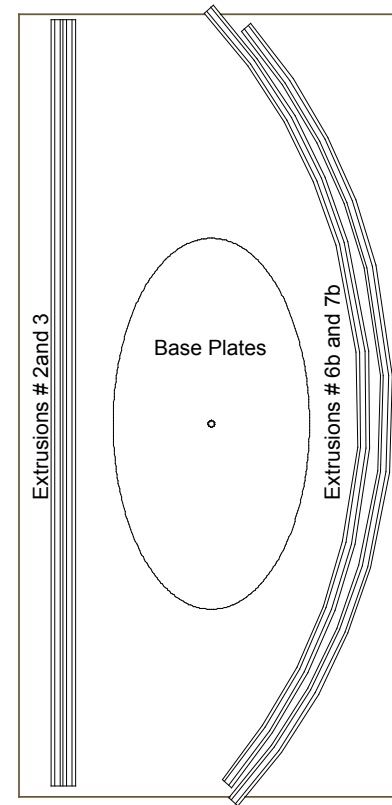

Level 3

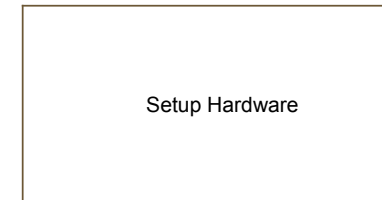

WHEN DISASSEMBLING ALUMINUM EXTRUSION, TIGHTEN ALL SETSCREWS AND LOCKS TO PREVENT LOSS DURING SHIPPING

MOD-1235 Components

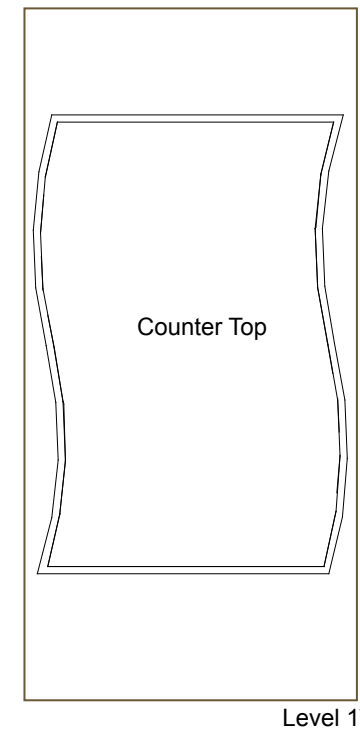
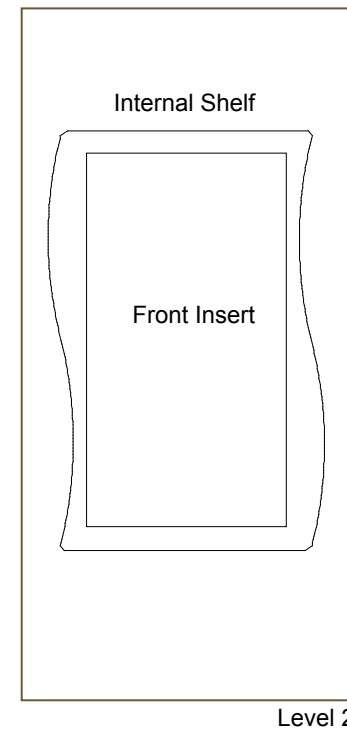
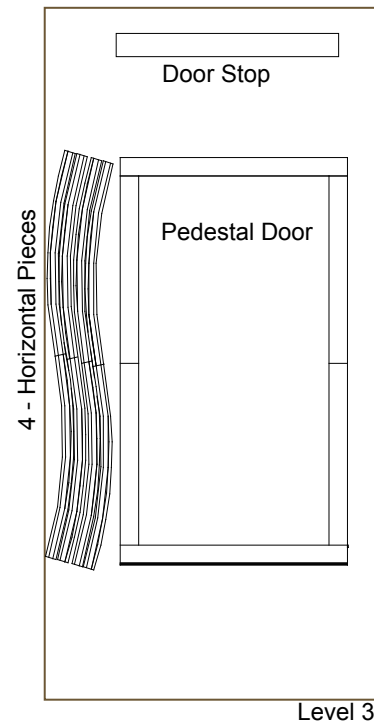
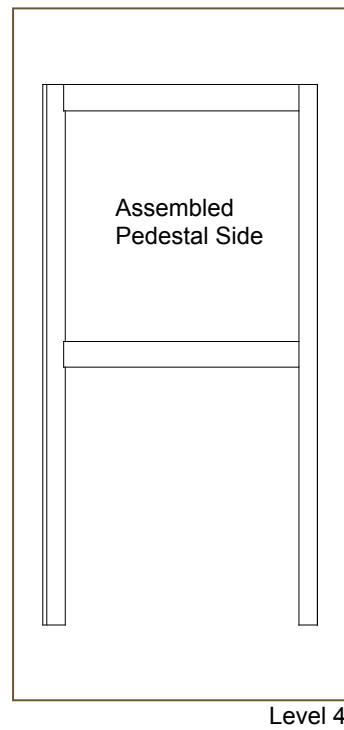
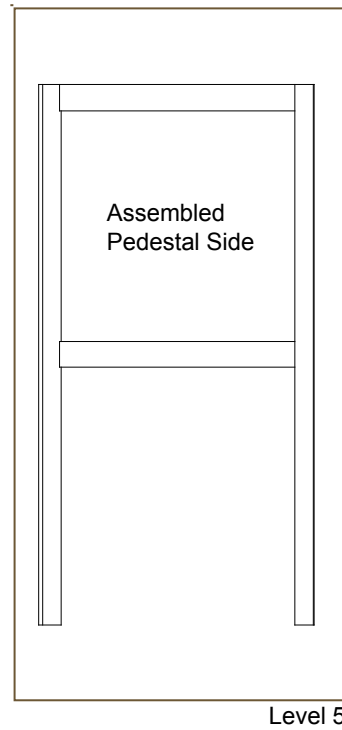

WHEN DISASSEMBLING ALUMINUM EXTRUSION, TIGHTEN ALL SETSCREWS AND LOCKS TO PREVENT LOSS DURING SHIPPING